

Article number: 201161VDEA5

Description: E+G Door lock GN 116.1-VDE-A5
VDE with double bit

Measures

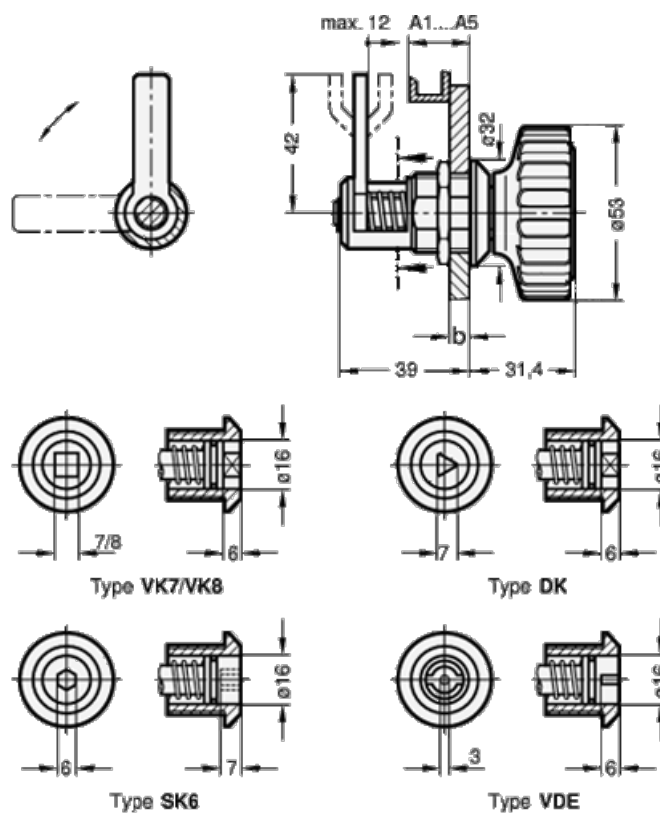

b max = 12
Door + frame thickness = 34-46